

Manual Switches

Advanced Manual Line

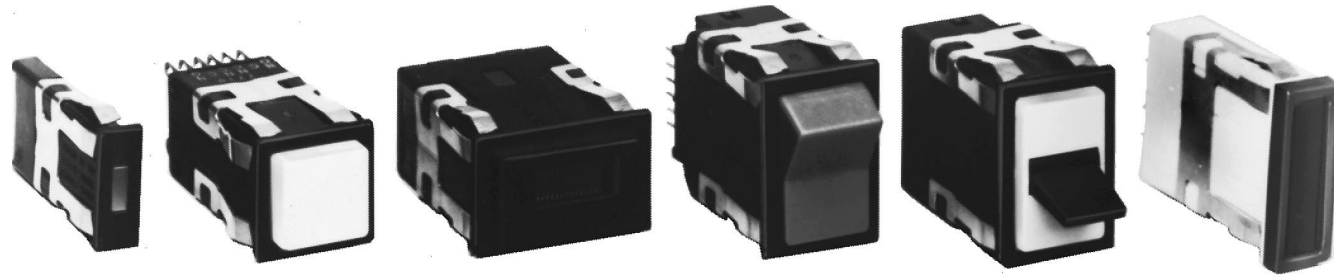

IN FRONT OF THE PANEL

Coordinated, attractive appearance. AML features innovations designed by industrial designers to achieve the best balance of human factors and aesthetic appearance. Operator height, bezel size, and the compatibility of square and rectangular shapes blend with other components to harmonize your panel. There's no visual clutter to distract from man/machine communication.

This comprehensive line of lighted and unlighted manual controls features:

- Pushbuttons for high and intermediate frequency functions;
- Rocker and paddle switches, with 2 or 3 positions, for less frequent control functions;
- Plus lighted indicators and annunciators which complement AML's universal appeal.

Various controls can be matched with their functions to accommodate the most natural and efficient habit pattern reflex. Keylock operated switches can be used to assure "authorized personnel only" access.

Display flexibility. AML offers a choice of five legend sizes, four button heights, full or split section display, and illumination by incandescent lamps, LED's or neons. Colors are bright and uniform, providing a strong definition and good visibility. (Non-illuminated devices have the same attractive colors.)

Color display options include:

- Transmitted color — color can be distinguished whether lamp is On or Off.
- Dead front — display appears black, until illumination causes legend and color to appear.
- Projected color — white display is diffused with color when illuminated.

BEHIND THE PANEL

AML's simple, cost effective design provides many behind-panel benefits for the designer and installer/user.

Simple to install. They snap in from the panel front individually or in vertical or horizontal strips; or in subpanel mounted strips and matrices that can be pre-assembled and pre-wired to assure accurate alignment and efficient panel building.

Electrical flexibility. Solid state switches with Hall effect integrated circuits interface directly with microprocessors and other logic level devices. These IC's were first applied in MICRO SWITCH solid state keyboards. Today, many MICRO SWITCH products incorporate the Hall effect technology to meet a wide range of position sensing and manual control needs.

Electronic control switches with gold or silver contacts, and 1, 2, or 4 poles, will handle up to 3 amps. Including an encoded version which generates different binary coded outputs merely by changing cam-keyed buttons.

Power duty switches meet line disconnect application needs with 10-amp push-buttons and 15-amp paddle and rocker switches.

Easy to wire. All AML devices present single level termination. This means faster, easier, neater, and more economical wiring. And there is a choice of solder, quick-connect, push-on, and printed circuit termination.

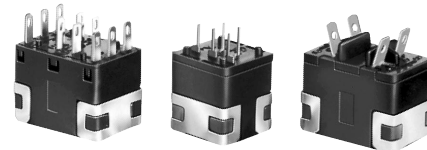

MATING RECEPTACLES

The .110 x .020 quick-connect/solder terminal (types 2 and 8) is designed for use with receptacles that comply with the UL standard for insertion and withdrawal forces. Maximum insertion force is 12 lbs. max., withdrawal force is 14 lbs. These receptacles are supplied by: AMP Inc., Berg, Augat, Hollingsworth, MALCO, Zierick, and others. Refer to Thomas Register or the Yellow Pages for the location of your local supplier.

Manuals

Manual Switches

Advanced Manual Line

FEATURES

- Complete selection of pushbutton, rocker and paddle (toggle type) switches accommodates different functions and promotes operator efficiency.
- Solid state, electronic, and power duty control.
- Full or split screen incandescent display switches and indicators provide vivid transmitted color, projected color (for neutral display when unlit), and dead front (hidden color).
- Wide-angle visibility LED and line voltage neon display switches and indicators.
- Annunciators back-lighted by LED's enable high density message display.
- Keylock switches available for controlled access applications.
- All AML terminations at the same shallow depth (1.7 in. /43,1 mm) for convenient wiring or PC board termination.
- Snap-in surface mount or sub-panel (hidden bezel) mount with mounting hardware.
- Pad printed legends with a clear polyurethane overcoat available in a choice of five standard sizes.
- Metric design for worldwide acceptance.
- UL recognized, CSA certification.
- Selected listings are certified by VDE and CE. (For compliance status, contact the 800 number.)

MICRO SWITCH AML Advanced Manual Line combines functional flexibility with electrical versatility to provide a broad range of options to choose from.

EASY TO RELAMP

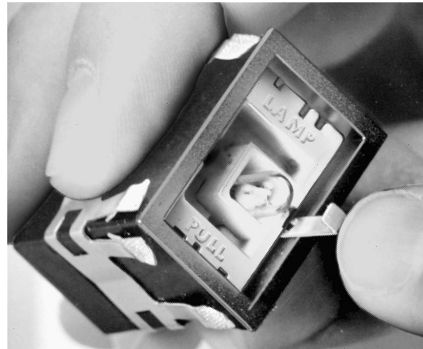

Relamping of T-1-3/4 incandescent AML91 lamps is accomplished from the front of the panel without tools. (AML92 T-1-3/4 LEDs can be added in the same manner.)

FULL GUARD BEZEL OPTION



As an alternative to standard height bezels (.06 in./1,5 mm), pushbutton switches can be furnished with full guard bezels extending .19 in./5.0 mm from the mounting surface. In the free position, standard buttons are flush with full guard bezels.

The raised bezel guards against accidental operation by someone leaning against or dropping something on a control console.

High Intensity LEDs For Full-face AML Lighted Display AML92 Series



- Full-face illumination for high visibility lighted colors.
- Advanced illumination technology combines high-intensity LED in standard T-1-3/4 wedge base lamp package.
- Easy plug-in installation in AML lighted switches and indicators.
- Low operating temperature permits high density, continuous operation with minimal heat build-up.

AML92 Series LEDs have a quad chip assembled in a T-1-3/4 wedge base lamp package. They provide full-face illumination when used with lighted pushbutton, rocker and paddle switches, or indicators equipped with incandescent lamp sockets. For ordering information, refer to page 46.

AML CHARACTERISTICS

	AML 10 Series	AML 20 Series	AML 30 Series	AML 40 Series
Electrical/Mechanical Life* Pushbuttons–Momentary	1,000,000	25,000 (silver)/ 100,000 (gold)	25,000	N/A ---
Pushbuttons–Alternate	25,000	25,000	25,000	---
Rockers	25,000	25,000	25,000	---
Paddles	25,000	25,000	25,000	---
Agency Ratings (May not apply to every series division)				
UL	File E53576	File E12252	File E12252	File E58932
CSA	File LR4442	File LR4442	File LR4442	File LR4442
VDE	None	File 0630/10.78+ Rating 1710	File 0630/10.78+ + Rating 1710	None
CE		No. 4275.5788	No. 4275.5788	

* 95% Survival
 + Exception: Four-Pole AML's are not included in VDE Approval
 ++ Exception: Only the 2-pole AML33 and AML34 are certified by VDE

AML ELECTRICAL DATA

● AML10 Series

Electrical Characteristics						Absolute Maximum Rating ^④			
Integrated Circuit Function	Supply Current (Max.)	Output Voltage (Operated)	Output Leakage Current max. (Released)	Switching Time Max.		Supply Voltage (V _s)	Voltage Externally Applied to Output	Loads to Output	Storage Temperature
				Rise 10% to 90%	Fall 90% to 10%				
4.5-24 VDC Sinking	5 V 7.0 mA (Released) 24 V 9.0 mA (Released) 14.0 mA (Operated-no load)	+ 4 Volt (Sinking 10 mA)	10 μA	1.5 μ sec (Sinking 10 mA)	0.5 μ sec (Sinking 10 mA)	-30 to +30 VDC	-0.5 Volt min. +24 Volts max. (Off condition)	20 mA (Sinking)	-40–C to +65°C (-40° to +149°F)

① Over temperature range of 0° to +55°C (+32° to +131°F) and supply voltage of 4.5 to 5.5 VDC.
 ② Over temperature range of 0° to +55°C (+32° to +131°F) and supply voltage of 16 VDC.
 ③ At 24°C. (+75°F)
 ④ As with all solid state components, performance can be expected to deteriorate as rating limits are approached; however, they will not be damaged unless the limits are exceeded.

● AML20 Series

Contacts	Voltage	Current	Load Type
Silver or Gold-plated Silver	250 VAC 125 VAC 24 VDC	2 Amps 3 Amps 2 Amps	75% Power Factor 75% Power Factor Resistive
Gold	125 VAC/DC	100 mA	Resistive

● AML30 Series

Voltage	Current		Load Type
	Pushbuttons	Rockers or Paddles	
125 VAC	10 amps	15 amps	60% power factor
250 VAC	10 amps	15 amps	60% power factor

Manuals

Manual Switches

Electronic Control Paddle

LED DISPLAY

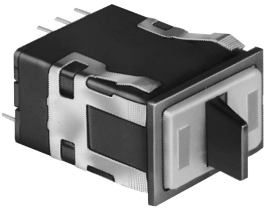

Covers with LED "window" ordered separately.

FEATURES

- Identical to AML23, except furnished with one or two rectangular high efficiency LED's which give flush display area and wide angle indication.
- Available with or without diode protection for LED's.
- LED circuit independent of switch circuit.

Electrical Data	page 11
Paddle Covers	page 36
Lamps and LEDs	page 46
Accessories	page 45
Mounting Dimensions	pages 47/50

- 5 thru 24 VDC devices have internal resistor to maintain current at nominal 20 mA.
- UL recognized, CSA certified.



*AML25 Series: 1 pole and 2-pole only.

AML25 ORDER GUIDE

AML25 F	B	B	2	AA	01	R	X
Housing Type	Operator/ Bezel Color	LED Voltage	Terminal Type/ Diode Protection	Circuitry Codes	Operating Code	LED Color (LED A)	LED Color (LED B)
AML25 F Rectangular 1 LED AML25 G Rectangular 2 LED's	B Black/Black	B V* C 5 V D 10 V E 15 V F 24 V	2 .110 × .020 (Solder or Q-C) 3 .025 × .025 (Printed Ckt., or Push-On) 8 .110 × .020 w/Diode protection	Insert code letters as shown in Circuitry Chart LED version available only with AA BA CA DA circuitry	Insert code numbers from Operating Action Chart	R Red Y Yellow G Green X No LED	R Red Y Yellow G Green X No LED

* See LED application information for devices without current-limiting resistor, page 46.

Example: **AML25FBB2AA01RX**
 Rectangular paddle switch; illuminated with one red LED, this device has a black paddle and bezel, and .110 × .020 terminals; with one circuit ON and one circuit OFF in each extreme operator position (maintained).

NOTE: For further information on replacement LED's, call the 800 number.

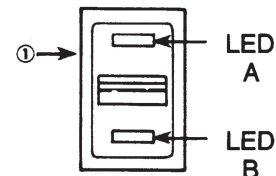
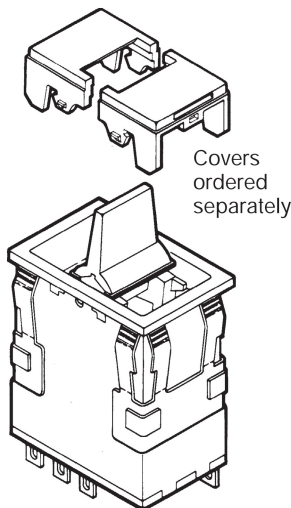

① The "MICRO SWITCH" identification is shown on this side of the switch housings.

Manuals

Manual Switches

Covers for Paddle Switches

AML55 PADDLE SWITCH COVER ORDER GUIDE (All possible color combinations may not be available.)

For AML15 and AML25 LED display.

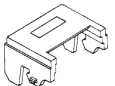
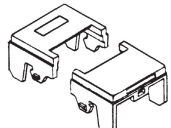
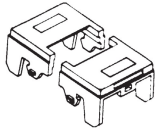
AML55-T	10	Y	R
Paddle Switch Cover Type  AML55-E 1/2 Cover (For one LED)*  AML55-T Two-Piece Cover (For one LED)  AML55-H Two-Piece Cover (For two LED's)	Display/Legend Type Transmitted Color 10 No Legend 20 With Legend	Cover Color – See notes below	
		1/2-cover, or LED side of two-piece covers*	Other side of two piece covers
		R Red Y Yellow G Green B Blue W White K Black L Gray	R Red Y Yellow G Green B Blue W White K Black L Gray

See notes below

HOW TO ORDER LEGENDS FOR PADDLE SWITCH COVERS

When specifying legended paddle switch covers, submit a legend order sheet to cover each catalog listing. These forms identify the maximum number of lines per area and the maximum characters per line, based on the type size you request.

To insure proper legend orientation, paddle switch housings (when viewed from the panel front) should have the "MICRO SWITCH" identification facing UP or to the LEFT.

Legend order sheets for covers are shown on the following pages. Reproduce them on your office copier or request a pad of them from the 800 number:

Legend Sheet	Form No.
AML53 Covers	FO-63567
AML55 Covers	FO-63565

AML55-E, -T, and -H covers have an open window which allows LED's to be flush with the cover surface.

* Notes:

¹ Only one color code letter is necessary for AML55-E 1/2 covers.

² To order a 1/2-cover without the LED "window," specify an AML53-E listing from the previous page.

Example: **AML55-T10YR**

Two-piece cover; with LED window in one side, transmitted color, no legend; yellow (LED side) and red (non-LED side).

Manual Switches

Switch Guard/Panel Plugs, Dummy Housings

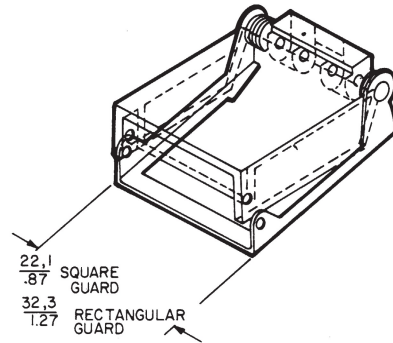
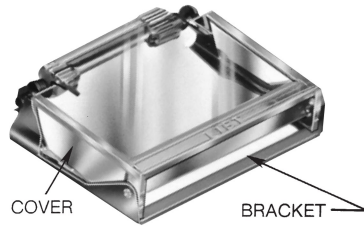

FEATURES

- Button cannot be operated when switch guard cover is closed, preventing accidental operation
- Wire lock-down feature further prevents unintentional actuation of the switch.
- Lamps can be replaced with the switch guard attached, without special tools, saving maintenance time
- Can be used with alternate or momentary action square or rectangular .19 inch standard height AML buttons
- Shock resistant construction, for long, maintenance-free life

AML76 switch guard protects square and rectangular .19-inch standard height pushbuttons from inadvertent actuation. It is for use with standard bezel type switches only.

See page 53 for mounting dimensions.

The switch guard cover is clear, polycarbonate thermoplastic through which the button is easily visible. The word "lift" is molded onto the top front edge of the guard. The bracket is bright-finished stainless steel.

The switch guard may be assembled to the AML pushbutton before the switch is installed in a panel. Or, the guard can be assembled to a pushbutton already mounted in a panel, providing the wiring is sufficiently slack to raise the switch bezel above the panel; and if there is sufficient clearance with adjacent units. PK 8522 contains installation instructions and is shipped with each order.

AML switch guards may be mounted in horizontal or vertical matrices. A wire lock-down feature, using .020-inch diameter locking wire, may be used as an additional protection.

SWITCH GUARD ORDER GUIDE

Guard Type*	Catalog Listing
Square	AML76C10T01P
Rectangular	AML76F10T01P

* The word "LIFT" is molded into the cover. If other languages are desired contact the 800 number.

Note: Switch guard is not designed for use with AML61 mounting hardware, AML71 barriers, or full guard bezel switches.

CONNECTOR BLOCK



AML79CC

This connector block can be used with square 1 and 2 pole AML21 and AML22 switches with .110 x .020 terminals to enable plug-in wiring.

Manuals

AML78 PANEL PLUGS

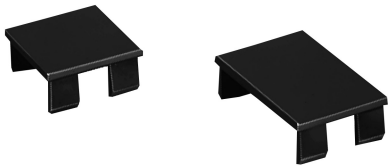

Plastic panel plugs (shown above) enable the user to provide for future needs by punching extra panel holes. Finished in matte black, they are the same height as the standard AML bezel when snapped in place from the panel front.

Panel plugs are only for use in individual holes or with AML61 mounting hardware in multi-station strips. (Use dummy housings in strip cutouts without AML61 mounting hardware.)

PANEL PLUG ORDER GUIDE

Plug Type	Catalog Listing
Square	AML78CB
Rectangular	AML78FB

AML78 DUMMY HOUSINGS

Dummy housings can be used to provide for expansion needs in strip cutouts without AML61 mounting hardware. They have mounting clips, but there is no provision for switching or illumination.

DUMMY HOUSING ORDER GUIDE

Dummy Housing Type*	Catalog Listing
Rectangular (Pushbutton style)	AML78F100
Rectangular (Lens indicator style)	AML78J100

* Order AML51 Buttons/lenses for use with dummy housings.

Manual Switches

Lamps, Soldering Recommendations, Receptacles

AML91 LAMP ORDER GUIDE

Lamp Type	Industry Lamp No.	Voltage	Catalog Listing
Incandescent T-1-3/4 wedge base	86	6.3	AML91LA86
	73	14.0	AML91LA73
	85	28.0	AML91LA85

LAMP DATA

The following data was compiled from manufacturer's specifications, for reference only.

INCANDESCENT LAMPS

Industry Lamp No.	Volts	Amps	Watts	MSCP	Life A/C Volts
86	6.3	.200	1.25	.49	20,000 hours
	5.5	.185	1.12	.246	106,200 hours
	5.0	.177	.89	.185	290,000 hours
73	14.0	.080	1.12	.30	15,000 hours
	12.0	.077	1.00	.23	36,450 hours
85	28.0	.04	1.12	.30	7,000 hours
	24.0	.037	.89	.177	41,860 hours

Neon Lamps

25,000 hours (half life)

INTEGRAL LEDs

LEDs Furnished Permanently Installed in These Products	V _f	I _f	V _{PD}	Peak Inverse Voltage	
				w/o Diode Protection	w/Diode Protection
AML12, 15, 16, 22, 25, 26, 42	2.4 V	20 mA	.7 V	5 V	34 V
AML45	2.4 V	20 mA	.7 V	4 V	33 V

100,000 hours (half life).

AML92 SERIES LEDs



For use with these AML switches and indicators equipped with lamp sockets:
Pushbutton switches: AML11 (Square Only)*, AML21 (rectangular and square), and AML31.

Paddle switches: AML31/23/33

Rocker switches: AML14/24/34

Indicators: AML41

* Rectangular solid state with one or two lamp circuits cannot be used with LED catalog listings ending in "L".

AML92 ORDER GUIDE

LED Color	Quad Chip	Six Chip
Red	AML92ERY	AML92ERL
Green	AML92EGY	AML92EGL
Yellow	AML92EYY	AML92EYL
White	—	AML92EWL**

** For use with white or yellow buttons.

OPERATING CHARACTERISTICS

Type	V _f Fwd. Voltage (typ.)				I _f Fwd. Current	V _r Rev. Voltage
	Yellow	Green	Red	White		
Quad Chip	8.6	8.6	7.8	—	15 mA	16 V
Six Chip	4 V	4 V	4 V	4 V	50 mA	5.6 V

TEMPERATURE RANGE

(Quad Chip or Six Chip)

Operating: -20 to 60°C (-4 to 140°F)

Storage: -30 to 100°C (-22 to 212°F)

SOLDERING RECOMMENDATIONS

All terminals are solder plated. Proper soldering and cleaning procedures must be followed to maintain the reliability of AML products during installation. An instruction sheet which outlines these procedures is included with AML shipments. You may also obtain a copy from your MICRO SWITCH Sales Office. Request PK 8518.

As a general guide, the following information may be used:

Use a 280°C (538°F) solder iron tip, up to 6 seconds duration, with a 60-40 rosin core solder. This allows the terminal to heat quickly on the exterior of the housing only, and greatly reduces the chance of flux migrating inside the housing.

LED APPLICATION INFORMATION

For those devices without internal current limiting resistors, suitable external control of the LED current must be provided. It is recommended that a minimum of 5 VDC open circuit voltage with an appropriate series resistance be used to drive LED devices. This minimizes the effect of temperature (current variation) on forward voltage of the LED.

Resistor values can be determined by supply voltage or current for LED:

$$R_s = \frac{E - V_f}{I_f}$$

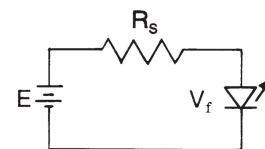

WHERE: R_s = Series Resistance
 E = Supply Voltage
 V_f = Forward Voltage of LED
 I_f = Circuit Current

If a diode is added in series for reverse polarity protection then:

$$R_s = \frac{E - V_f - V_{PD}}{I_f}$$

WHERE: V_{PD} Forward Voltage of Protection Diode

Mounting Dimensions (For Reference Only)

**AML11/12 and 21/22 SWITCHES
AML41C/D and AML42C INDICATORS**

Note: Top of full guard bezel housing .19/5,0 from panel.

PUSHBUTTONS

For terminal locations, see page 49.

AML27 SWITCHES

KEYLOCK

For terminal locations, see page 50.

AML14/16 and AML24/26 SWITCHES

ROCKERS

For terminal locations, see page 49/50.

AML13/15 and 23/25 SWITCHES

PADDLES

LED Location Same as Rocker

For terminal locations, see page 49/50.

AML41 INDICATOR

LENS STYLE

For terminal locations, see page 50.

NOTE
1 Dimensions are mm or mm/IN
IN

AML42 INDICATOR

MINIATURE

TERMINAL TYPES

Solder Hole will accept two #22 AWG Stranded Conductor (per NEMA publication DC-2 1976)

Manuals